

Professional Plus

Rispetto alla linea Professional, la linea Plus ha:

- * Manopole e maniglie maggiorate
- * Cassetto scaldapiatti

CARATTERISTICHE



PIEDINI INOX
Altezza da 10 a 16 cm



CASSETTO SCALDAPIATTI
Cassetto scaldapiatti ideale per scaldare i piatti quando il forno è in uso

CARATTERISTICHE:

- * Robuste griglie in ghisa
- * Accensione elettrica integrata sulle manopole
- * Ventilazione tangenziale

- * Valvolatura di sicurezza sui fuochi
- * Porta fredda a triplo vetro

GAMMA COLORI

HI-TECH



INOX Versione "W"



INOX Versione "L"



MAT-GRAFITE Solo su estetica "PF"

GAMMA COLORI

Nostalgie



BLU MEZZANOTTE



ROSSO BORGOGNA



MAT-GRAFITE



VERDE SMERALDO



BIANCO ANTICO



INOX



MANOPOLE E MANIGLIONE IN ACCIAIO

Nostalgie



MANOPOLE E MANIGLIONE IN OTTONE DI SERIE



MANOPOLE E MANIGLIONE CROMATI A RICHIESTA
SENZA SOVRAPREZZO



MANOPOLE E MANIGLIONE BRUNITI A RICHIESTA
CON SOVRAPREZZO

COLORI OPZIONALI



CUCINE
PROFESSIONAL PLUS



Bianco e nero lucido per tutti i modelli *Nostalgie* e Plus "PW"

(disponibili in 30 giorni lavorativi)

VEDI LISTA ACCESSORI NELLA PARTE INIZIALE DEL CATALOGO.

GRUPPI DI COTTURA «PROFESSIONAL PLUS» CON DECORI APPLICATI



Su determinati modelli della serie Professional Plus con estetica "W" è possibile applicare i decori colorati come da foto di queste pagine. I kit consistono in pannelli in acciaio inox, successivamente colorati, che vengono incollati su cruscotto, porta e cassetto del blocco di cottura inox. In alcuni modelli i pannelli vengono applicati anche ai profili laterali. I decori disponibili ed i relativi prezzi sono riportati sotto.

(disponibili in 30 giorni lavorativi)

DECPW60/03/...	€	DECPW906/03/...	€	DECPW120/03/...	€
DECPW70/03/...	€	DECPDW90/03/...	€	DECPDW120/03/...	€
DECPW76/03/...	€	DECPDW906/03/...	€	DECPDW120/03/...	€
DECPW80/03/...	€	DECPDW100/03/...	€	DECPW150/03/...	€
DECPW90/03/...	€	DECPDW1006/03/...	€		



GAMMA COLORI

Peltro	Grafite-Mat	Bianco Antico
Rosso borgogna	Blu	Verde smeraldo
Bianco	Nero lucido	Ramato

PIANO DI LAVORO INOX







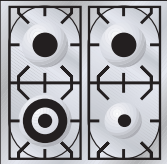
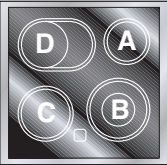

CARATTERISTICHE TECNICHE:

Forno multifunzione 60: • classe energetica **A**; • termostato; • programmatore elettronico; • grill elettrico.

Forno a gas ventilato 60: • termostato con termocoppia; • grill elettrico; • programmatore elettronico per funzioni grill e grill ventilato.

Tutti i modelli sono dotati di porta fredda a triplo vetro.

Tipologia piano cottura	Tipologia forno	Codice modello	Prezzo €
4 fuochi 	Multifunzione	PL-60-MP	
		PW-60-MP	
		PF-60-MP	
	A gas ventilato	PL-60-VG	
		PW-60-VG	
		PF-60-VG	
Vetroceramica 	Multifunzione	PLE-60-MP	
		PWE-60-MP	
		PFE-60-MP	
	A - ø 145 mm - 1200W B - ø 210/120 mm - 2200W/750W C - ø 180 mm - 1800W D - ø 265/170 mm - 2400W/1500W		
Induzione 	Multifunzione	PLI-60-MP	
		PWI-60-MP	
		PFI-60-MP	
	A - ø 145 mm - 1400W B - ø 180 mm - 1850W C - ø 210 mm - 2300W		

GAMMA COLORI	
 Inox	 Grafite-Mat (no PL-60)
 Bianco (versione PW-60)	 Nero lucido (versione PW-60)
PIANO DI LAVORO INOX	

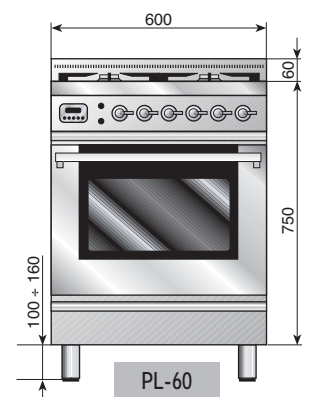
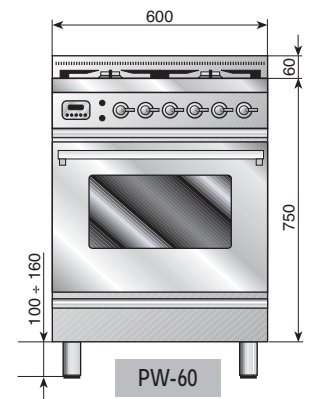
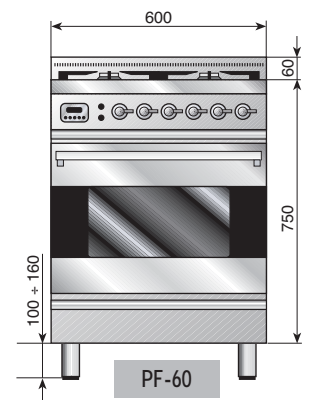

PROFONDITÀ 60









CARATTERISTICHE TECNICHE:

Forno multifunzione 60: • classe energetica **A** • termostato; • programmatore elettronico; • grill elettrico

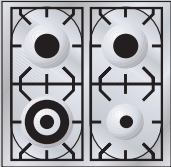
Forno a gas ventilato 60: • termostato con termocoppia; • grill elettrico; • programmatore elettronico per funzioni grill e grill ventilato.

Tutti i modelli sono dotati di porta fredda a triplo vetro.

Tipologia piano cottura	Tipologia forno	Codice modello	Prezzo €
4 fuochi 	Multifunzione	PL-70-MP	
		PW-70-MP	
		PF-70-MP	
	A gas ventilato	PL-70-VG	
		PW-70-VG	
		PF-70-VG	

GAMMA COLORI	
	
Inox	Grafite-Mat (no PL-70)
	
Bianco (versione PW-70)	Nero lucido (versione PW-70)
PIANO DI LAVORO INOX	

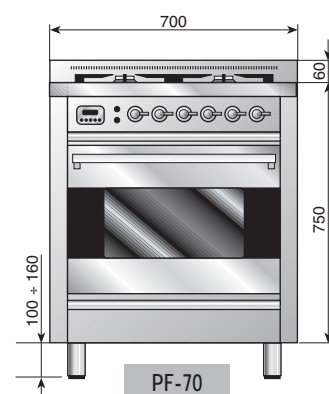
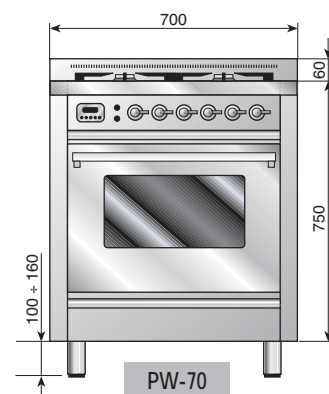
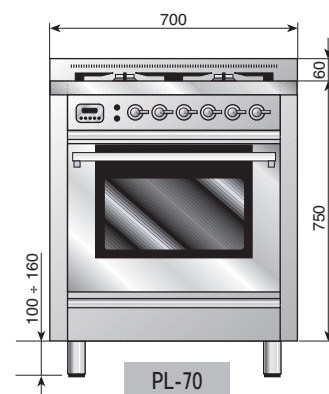
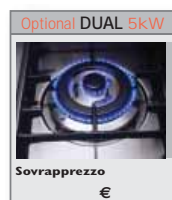

PROFONDITÀ 60



CARATTERISTICHE TECNICHE:

Maxiforno multifunzione 70: • classe energetica **A**; • termostato; • programmatore elettronico; • grill elettrico

Maxiforno a gas ventilato 70: • termostato con termocoppia; • grill elettrico; • programmatore elettronico per funzioni grill e grill ventilato.

Tutti i modelli sono dotati di porta fredda a triplo vetro.

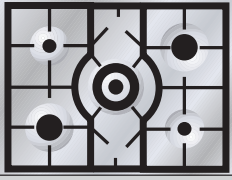
Tipologia piano cottura	Tipologia forno	Codice modello	Prezzo €
5 Fuochi 	Multifunzione	PW-76-MP	
	A gas ventilato	PW-76-VG	

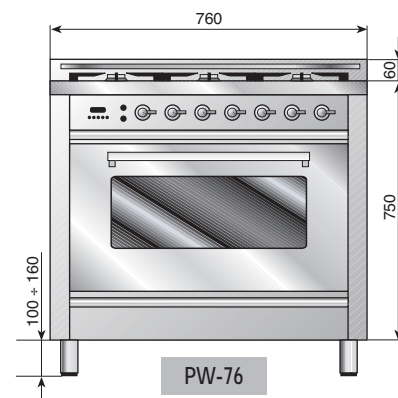
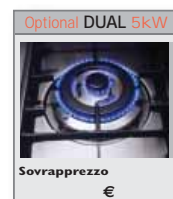

PROFONDITÀ 60







CARATTERISTICHE TECNICHE:

Maxiforno multifunzione 90: • classe energetica **A**; • termostato; • programmatore elettronico; • girarrosto; • grill elettrico.

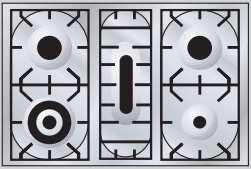
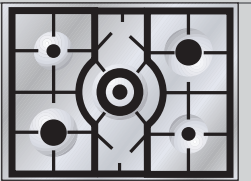
Maxiforno a gas ventilato 90: • termostato con termocoppia; • grill elettrico; • programmatore elettronico per funzioni grill e grill ventilato.

Tutti i modelli sono dotati di porta fredda a triplo vetro.

Tipologia piano cottura	Tipologia forno	Codice modello	Prezzo €
Pesciera 	Multifunzione	PL-80-MP	
		PW-80-MP	
		PF-80-MP	
	A gas ventilato	PL-80-VG	
		PW-80-VG	
		PF-80-VG	
5 fuochi 	Multifunzione	PL-80C-MP	
		PW-80C-MP	
		PF-80C-MP	
	A gas ventilato	PL-80C-VG	
		PW-80C-VG	
		PF-80C-VG	

GAMMA COLORI	
	
Inox	Grafite-Mat (no PL-80)
	
Bianco (versione PW-80)	Nero lucido (versione PW-80)
PIANO DI LAVORO INOX	



PF-80-MP

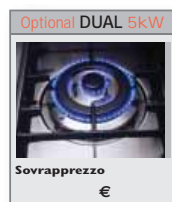

PW-80C

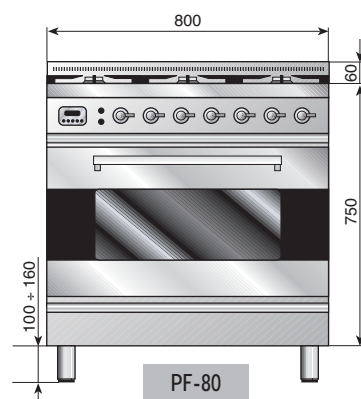
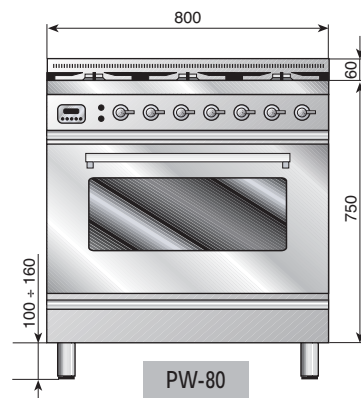
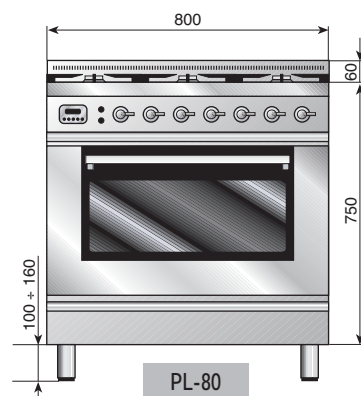

PROFONDITÀ 60





CARATTERISTICHE TECNICHE:

Maxiforno multifunzione 90: • classe energetica **A**; • termostato; • programmatore elettronico; • girarrosto; • grill elettrico.

Maxiforno a gas ventilato 90: • termostato con termocoppia; • grill elettrico; • programmatore elettronico per funzioni grill e grill ventilato.

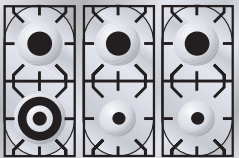
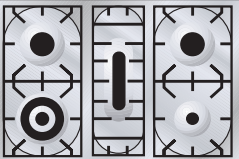
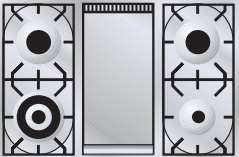
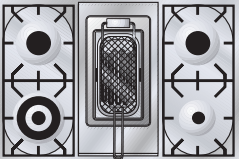
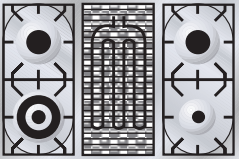
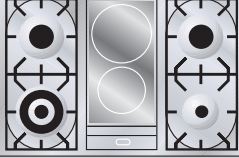
Tutti i modelli sono dotati di porta fredda a triplo vetro.

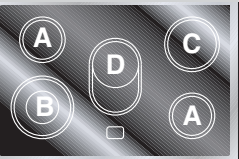
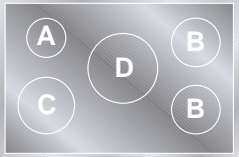
Tipologia piano cottura	Tipologia forno	Codice modello	Prezzo €
6 fuochi 	Multifunzione	PL-906-MP	
		PW-906-MP	
		PF-906-MP	
	A gas ventilato	PL-906-VG	
		PW-906-VG	
		PF-906-VG	
Pesciera 	Multifunzione	PL-90-MP	
		PW-90-MP	
		PF-90-MP	
	A gas ventilato	PL-90-VG	
		PW-90-VG	
		PF-90-VG	
Fry-Top 	Multifunzione	PL-90F-MP	
		PW-90F-MP	
		PF-90F-MP	
	A gas ventilato	PL-90F-VG	
		PW-90F-VG	
		PF-90F-VG	
Friggitrice 	Multifunzione	PL-90R-MP	
		PW-90R-MP	
	A gas ventilato	PF-90R-MP	
		n.d.	
Barbecue 	Multifunzione	PL-90B-MP	
		PW-90B-MP	
		PF-90B-MP	
	A gas ventilato	PL-90B-VG	
		PW-90B-VG	
		PF-90B-VG	
2 Zone Induzione 	Multifunzione	PL-90I-MP	
		PW-90I-MP	
		PF-90I-MP	
		Optional Fry Top G/419/08	2 x 1850 W 
Vetroceramica 	Multifunzione	PLE-90-MP	
		PWE-90-MP	
		PFE-90-MP	
		A - ø 145 mm - 1200W B - ø 210/120 mm - 2200W/750W C - ø 180 mm - 1800W D - ø 265/170 mm - 2400W/1500W	
Induzione 	Multifunzione	PLI-90-MP	
		PWI-90-MP	
		PFI-90-MP	
		A - ø 145 mm - 1400W B - ø 180 mm - 1850W C - ø 210 mm - 2300W D - ø 260 mm - 2400W	

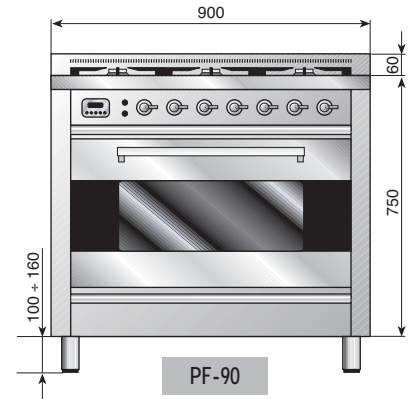
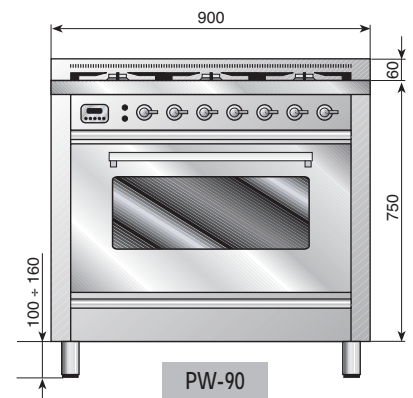
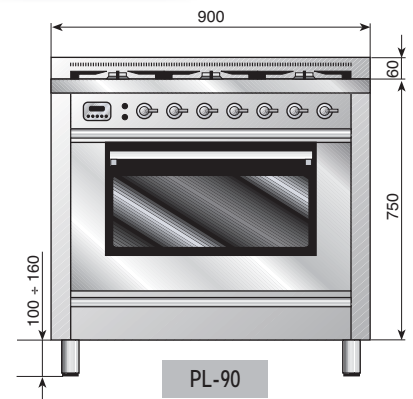
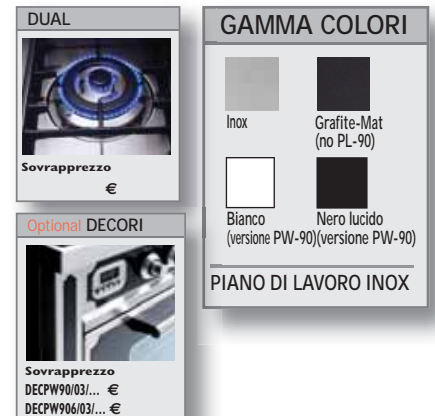

PROFONDITÀ 60



GRUPPO DI COTTURA «PROFESSIONAL PLUS» HI-TECH PD-90

CARATTERISTICHE TECNICHE:





Forno di sinistra: standard 60 in versione multifunzione o gas ventilato. Forno di destra: mini 30 elettrico statico.

Forno multifunzione 60: • classe energetica **A**; • termostato; • programmatore elettronico; • grill elettrico.

Mini forno elettrico 30: • classe energetica **A**; • grill elettrico; • girarrosto.

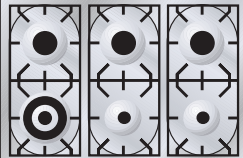
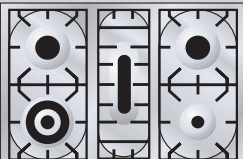
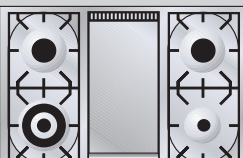
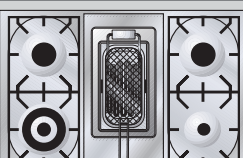
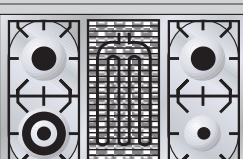
Forno a gas ventilato 60: • termostato con termocoppia; • grill elettrico; • programmatore elettronico.

Tutti i modelli sono dotati di porta fredda a triplo vetro.

Tipologia piano cottura	Tipologia forno	Codice modello	Prezzo €
6 fuochi 	Multifunzione	PDL-906-MP	
		PDW-906-MP	
		PDF-906-MP	
	A gas ventilato	PDL-906-VG	
		PDW-906-VG	
		PDF-906-VG	
Pesciera 	Multifunzione	PDL-90-MP	
		PDW-90-MP	
		PDF-90-MP	
	A gas ventilato	PDL-90-VG	
		PDW-90-VG	
		PDF-90-VG	
Fry-Top 	Multifunzione	PDL-90F-MP	
		PDW-90F-MP	
		PDF-90F-MP	
	A gas ventilato	PDL-90F-VG	
		PDW-90F-VG	
		PDF-90F-VG	
Friggitrice 	Multifunzione	PDL-90R-MP	
		PDW-90R-MP	
		PDF-90R-MP	
	A gas ventilato	n.d.	
Barbecue 	Multifunzione	PDL-90B-MP	
		PDW-90B-MP	
		PDF-90B-MP	
	A gas ventilato	PDL-90B-VG	
		PDW-90B-VG	
		PDF-90B-VG	
1 Zona vetroceramica 	Multifunzione	PDL-90V-MP	
		PDW-90V-MP	
		PDF-90V-MP	
	A gas ventilato	PDL-90V-VG	
		PDW-90V-VG	
		PDF-90V-VG	
	Multifunzione	PDLE-90-MP	
		PDWE-90-MP	
		PDFE-90-MP	
		A - ø 145 mm - 1200W B - ø 210/120 mm - 2200W/750W C - ø 180 mm - 1800W D - ø 265/170 mm - 2400W/1500W	
	Multifunzione	PDLI-90-MP	
		PDWI-90-MP	
		PDFI-90-MP	
		A - ø 145 mm - 1400W B - ø 180 mm - 1850W C - ø 210 mm - 2300W D - ø 260 mm - 2400W	

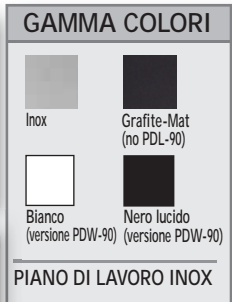
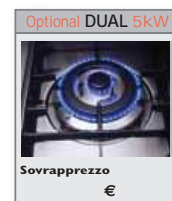

PROFONDITÀ 60

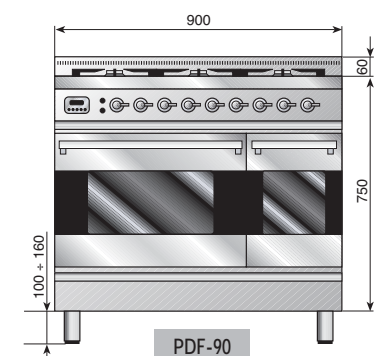
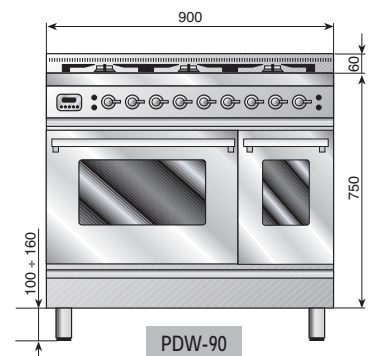
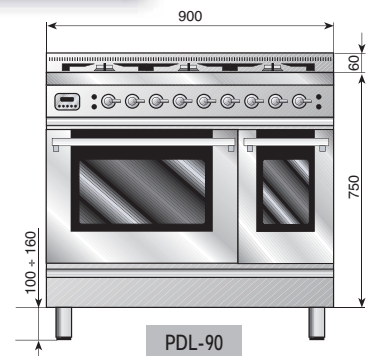



GRUPPO DI COTTURA «PROFESSIONAL PLUS» HI-TECH PD-100

CARATTERISTICHE TECNICHE:

Forno di sinistra: standard 60 in versione multifunzione o gas ventilato. Forno di destra: midi 40 elettrico statico.

Forno multifunzione 60: • classe energetica **A**; • termostato; • programmatore elettronico; • grill elettrico.

Midi forno elettrico 40: • classe energetica **A**; • grill elettrico; • girarrosto.

Forno a gas ventilato 60: • termostato con termocoppia; • grill elettrico; • programmatore elettronico.

Tutti i modelli sono dotati di porta fredda a triplo vetro.



*Microonde su forno Midi 40

6 fuochi *	Multifunzione	A gas ventilato	Multif. 60 + Microonde 40 (con controllo E3 300°C)															
	PDL-1006-MP PDW-1006-MP PDF-1006-MP	PDL-1006-VG PDW-1006-VG PDF-1006-VG	PDL-1006-MW PDW-1006-MW PDF-1006-MW															
€	€	€	€															
Fry-Top *	PDL-100F-MP PDW-100F-MP PDF-100F-MP	PDL-100F-VG PDW-100F-VG PDF-100F-VG	PDL-100F-MW PDW-100F-MW PDF-100F-MW															
€	€	€	€															
Coup De Feu	PDL-100S-MP PDW-100S-MP PDF-100S-MP	PDL-100S-VG PDW-100S-VG PDF-100S-VG																
€	€																	
Friggitrice	PDL-100R-MP PDW-100R-MP PDF-100R-MP																	
€																		
Barbecue	PDL-100B-MP PDW-100B-MP PDF-100B-MP	PDL-100B-VG PDW-100B-VG PDF-100B-VG																
€ 2.947,00	€ 2.947,00																	
1 Zona vetroceramica	PDL-100V-MP PDW-100V-MP PDF-100V-MP	PDL-100V-VG PDW-100V-VG PDF-100V-VG																
€	€																	
Vetroceramica *	PDLE-100-MP PDWE-100-MP PDFE-100-MP	<table border="1"> <thead> <tr> <th></th> <th>ø mm</th> <th>W</th> </tr> </thead> <tbody> <tr> <td>A</td> <td>145</td> <td>1200</td> </tr> <tr> <td>B</td> <td>210/120</td> <td>2200/750</td> </tr> <tr> <td>C</td> <td>180</td> <td>1800</td> </tr> <tr> <td>D</td> <td>265/170</td> <td>2400/1500</td> </tr> </tbody> </table>		ø mm	W	A	145	1200	B	210/120	2200/750	C	180	1800	D	265/170	2400/1500	PDL-100-MW PDWE-100-MW PDFE-100-MW
	ø mm	W																
A	145	1200																
B	210/120	2200/750																
C	180	1800																
D	265/170	2400/1500																
€	€		€															
Induzione *	PDLI-100-MP PDWI-100-MP PDFI-100-MP	<table border="1"> <thead> <tr> <th></th> <th>ø mm</th> <th>W</th> </tr> </thead> <tbody> <tr> <td>A</td> <td>145</td> <td>1400</td> </tr> <tr> <td>B</td> <td>180</td> <td>1850</td> </tr> <tr> <td>C</td> <td>210</td> <td>2300</td> </tr> </tbody> </table>		ø mm	W	A	145	1400	B	180	1850	C	210	2300	PDLI-100-MW PDWI-100-MW PDFI-100-MW			
	ø mm	W																
A	145	1400																
B	180	1850																
C	210	2300																
€	€		€															

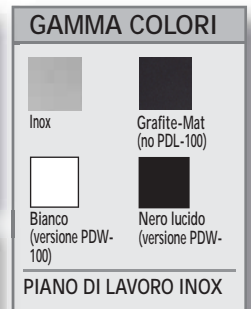

PROFONDITÀ 60

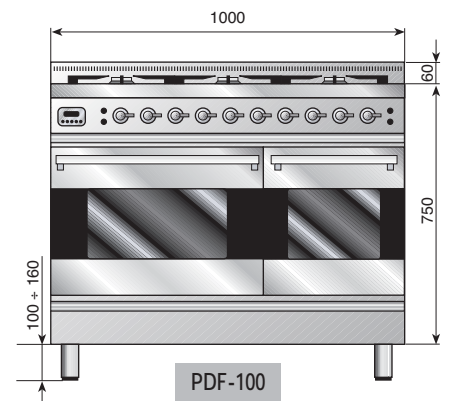
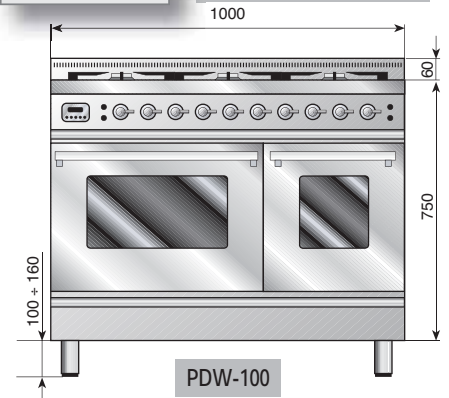





GRUPPO DI COTTURA «PROFESSIONAL PLUS» HI-TECH PT-100

CARATTERISTICHE TECNICHE:

Forni lato sinistro - Superiore: • grill elettrico. Inferiore: multifunzione 60: • classe energetica **A**; • termostato; • programmatore elettronico; • grill elettrico.

Forno lato destro - Superiore: midi 40 elettrico: • classe energetica **A**; • grill elettrico; • girarrosto. Cassetto portaoggetti.

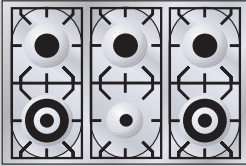
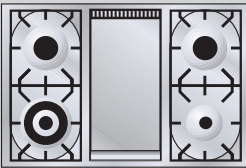
Tutti i modelli sono dotati di porta fredda a triplo vetro.

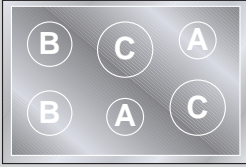
Tipologia piano cottura	Tipologia forno	Codice modello	Prezzo €
6 fuochi 	Multifunzione	PTW-1006-MP	
		PTQ-1006-MP	
Fry-Top 	Multifunzione	PTW-100F-MP	
		PTQ-100F-MP	
Vetroceramica 	Multifunzione	PTWE-100-MP	
		PTQE-100-MP	
A - ø 145 mm - 1200W B - ø 210/120 mm - 2200W/750W C - ø 180 mm - 1800W D - ø 265/170 mm - 2400W/1500W			
Induzione 	Multifunzione	PTWI-100-MP	
		PTQI-100-MP	
A - ø 145 mm - 1400W B - ø 180 mm - 1850W C - ø 210 mm - 2300W			

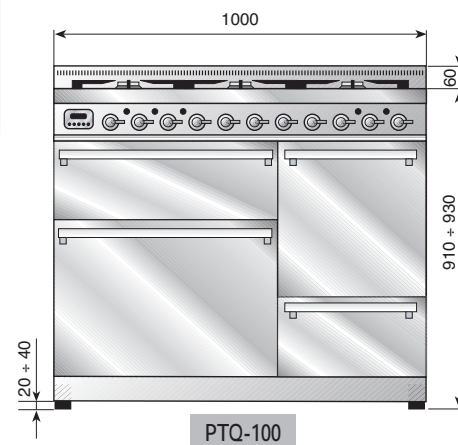
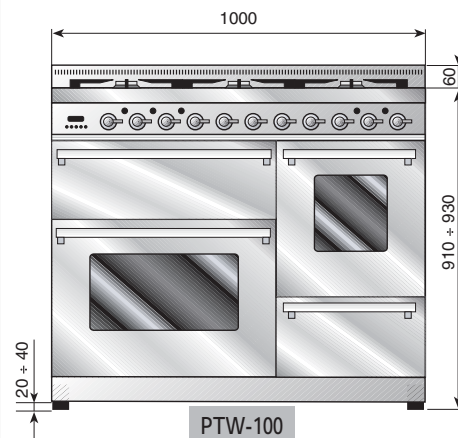
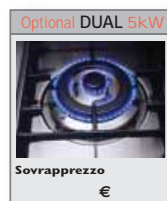

PROFONDITÀ 60





GRUPPO DI COTTURA «PROFESSIONAL PLUS» HI-TECH PT-110

CARATTERISTICHE TECNICHE:

Forni lato sinistro - Superiore: • grill elettrico. **Inferiore: multifunzione 60:** • classe energetica **A**; • termostato; • programmatore elettronico; • grill elettrico.

Forno lato destro - Superiore: midi 40 elettrico: • classe energetica **A**; • grill elettrico; • girarrosto. **Cassetto portaoggetti.**

Tutti i modelli sono dotati di porta fredda a triplo vetro.

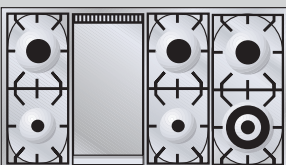
Tipologia piano cottura	Tipologia forno	Codice modello	Prezzo €
Fry-Top 	Multifunzione	PTW-110F-MP	
		PTQ-110F-MP	

GAMMA COLORI



PIANO DI LAVORO INOX

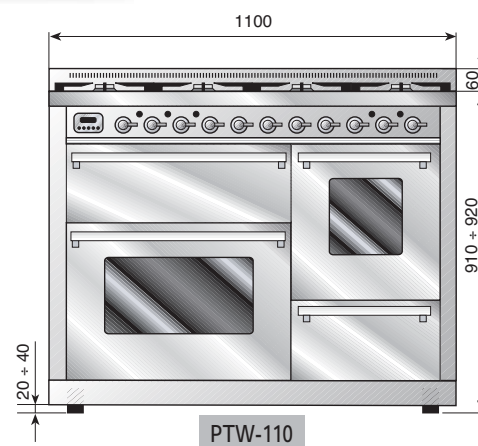
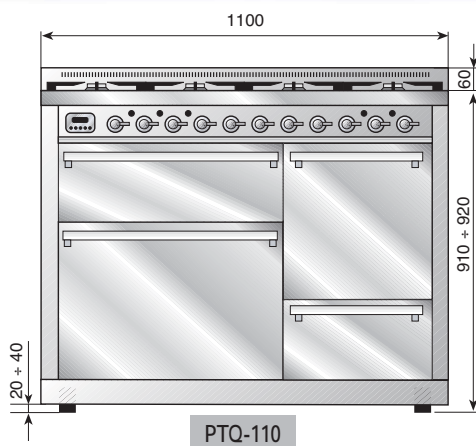

PROFONDITÀ 60



GRUPPO DI COTTURA «PROFESSIONAL PLUS» HI-TECH P-120

CARATTERISTICHE TECNICHE:



Forno di sinistra: maxiforno 90 in versione multifunzione o gas ventilato. Forno di destra: mini 30 elettrico statico.

Maxiforno multifunzione 90: • classe energetica **A**; • termostato; • programmatore elettronico; • girarrosto; • grill elettrico.

MiniForno elettrico 30: • classe energetica **A**; • grill elettrico; • girarrosto.

Maxiforno a gas ventilato 90: • termostato con termocoppia; • grill elettrico; • programmatore elettronico.

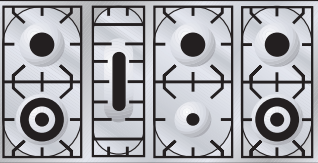
Tutti i modelli sono dotati di porta fredda a triplo vetro.

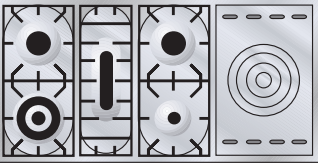
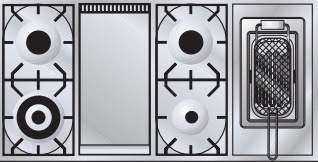
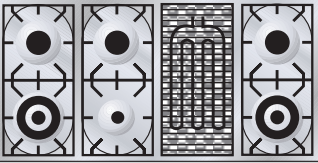
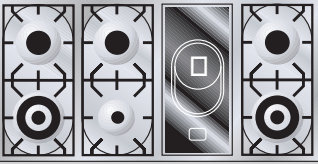
Tipologia piano cottura	Tipologia forno	Codice modello	Prezzo €
7 fuochi 	Multifunzione	PL-I207-MP	
		PW-I207-MP	
		PF-I207-MP	
	A gas ventilato	PL-I207-VG	
		PW-I207-VG	
		PF-I207-VG	
Fry-Top 	Multifunzione	PL-I20F-MP	
		PW-I20F-MP	
		PF-I20F-MP	
	A gas ventilato	PL-I20F-VG	
		PW-I20F-VG	
		PF-I20F-VG	
Coup De Feu 	Multifunzione	PL-I20S-MP	
		PW-I20S-MP	
		PF-I20S-MP	
	A gas ventilato	PL-I20S-VG	
		PW-I20S-VG	
		PF-I20S-VG	
Friggitrice 	Multifunzione	PL-I20FR-MP	
		PW-I20FR-MP	
		PF-I20FR-MP	
	A gas ventilato	n.d.	
Barbecue 	Multifunzione	PL-I20B-MP	
		PW-I20B-MP	
		PF-I20B-MP	
	A gas ventilato	PL-I20B-VG	
		PW-I20B-VG	
		PF-I20B-VG	
1 Zona vetroceramica 	Multifunzione	PL-I20V-MP	
		PW-I20V-MP	
		PF-I20V-MP	
	A gas ventilato	PL-I20V-VG	
		PW-I20V-VG	
		PF-I20V-VG	

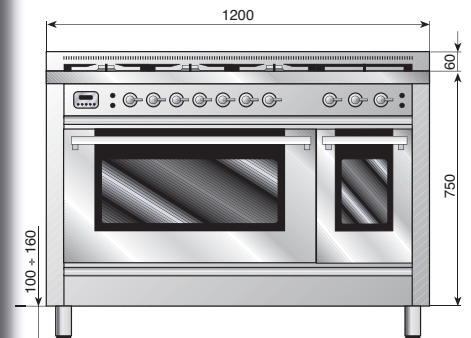
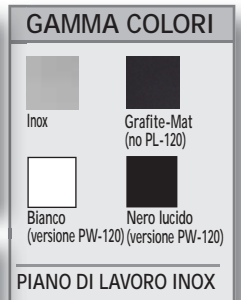
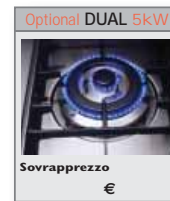

PL-120

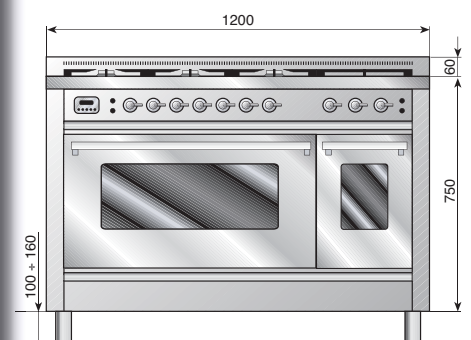

PW-120

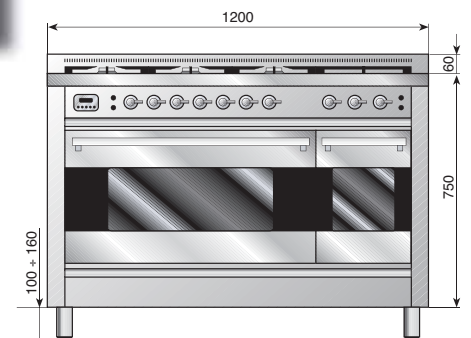

PF-120

PROFONDITÀ 60



Maxiforno 90 cm

Mini 30 cm



GRUPPO DI COTTURA «PROFESSIONAL PLUS» HI-TECH PS-120

CARATTERISTICHE TECNICHE:

Forno di sinistra: maxiforno 70 in versione multifunzione o gas ventilato. Forno di destra: midi 40 elettrico statico.

Maxiforno multifunzione 70: • classe energetica **A**; • termostato; • programmatore elettronico; • girarrosto; • grill elettrico.

Maxiforno a gas ventilato 70: • termostato con termocoppia; • grill elettrico; • programmatore elettronico.

MidiForno elettrico 40: • classe energetica **A**; • grill elettrico; • girarrosto.

Tutti i modelli sono dotati di porta fredda a triplo vetro.

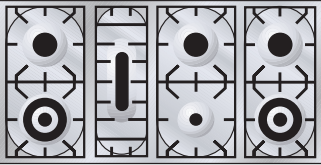
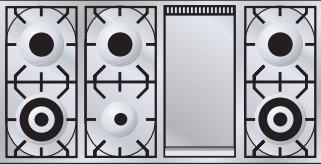
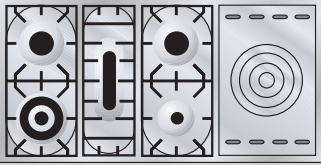
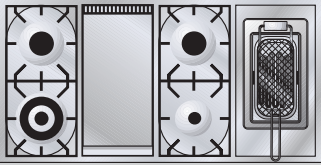
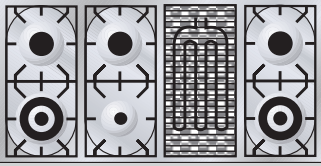
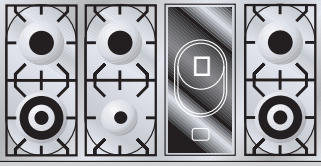
Tipologia piano cottura	Tipologia forno	Codice modello	Prezzo €
7 fuochi 	Multifunzione	PSL-I207-MP	
		PSW-I207-MP	
	A gas ventilato	PSL-I207-VG	
		PSW-I207-VG	
Fry-Top 	Multifunzione	PSL-I20F-MP	
		PSW-I20F-MP	
	A gas ventilato	PSL-I20F-VG	
		PSW-I20F-VG	
Coup De Feu 	Multifunzione	PSL-I20S-MP	
		PSW-I20S-MP	
	A gas ventilato	PSL-I20S-VG	
		PSW-I20S-VG	
Friggitrice 	Multifunzione	PSL-I20FR-MP	
		PSW-I20FR-MP	
	A gas ventilato	n.d.	
Barbecue 	Multifunzione	PSL-I20B-MP	
		PSW-I20B-MP	
	A gas ventilato	PSL-I20B-VG	
		PSW-I20B-VG	
1 Zona vetroceramica 	Multifunzione	PSL-I20V-MP	
		PSW-I20V-MP	
	A gas ventilato	PSL-I20V-VG	
		PSW-I20V-VG	

Optional DUAL 5kW



**GAMMA
COLORI**



Optional DECORI



PIANO DI LAVORO INOX

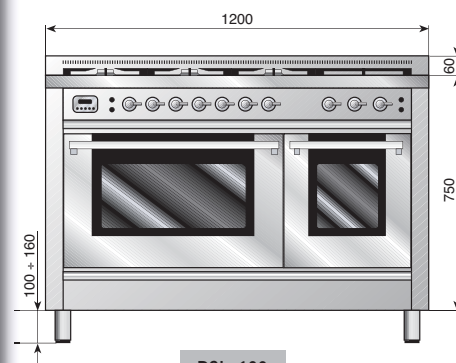

PSL-120

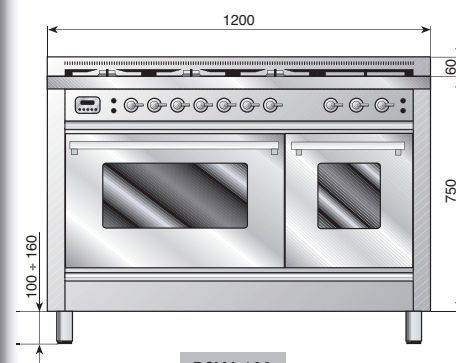

PSW-120

PROFONDITÀ 60

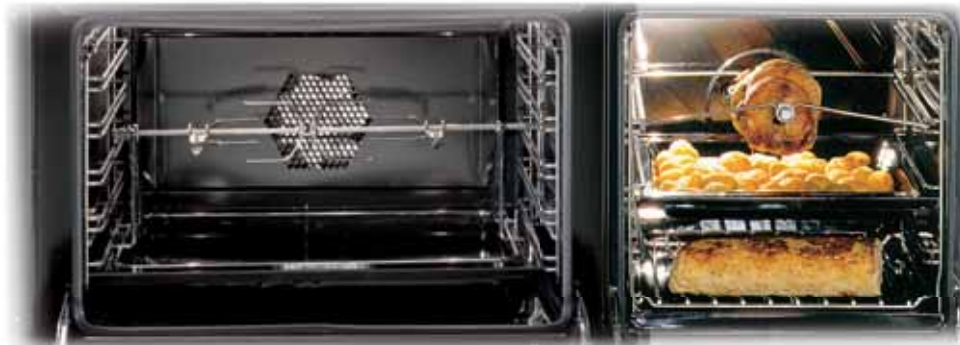

Forno 70 cm

Midi 40 cm



55335

GRUPPO DI COTTURA «PROFESSIONAL PLUS» HI-TECH PD-120

CARATTERISTICHE TECNICHE:

Forno di sinistra: standard 60 in versione multifunzione o gas ventilato. Forno di destra: standard 60 multifunzione.

Forno multifunzione 60: • classe energetica **A**; • termostato; • programmatore elettronico; • grill elettrico.

Forno a gas ventilato 60: • termostato con termocoppia; • grill elettrico; • programmatore elettronico.

Tutti i modelli sono dotati di porta fredda a triplo vetro.

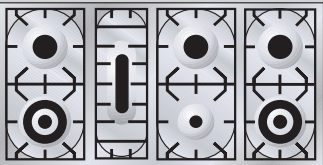
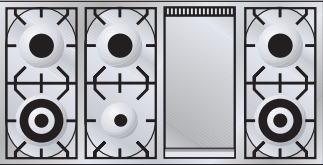
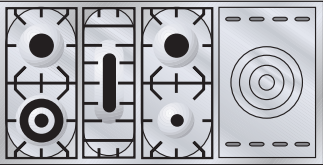
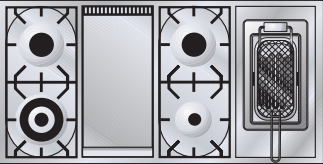
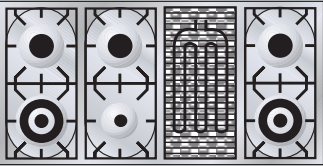
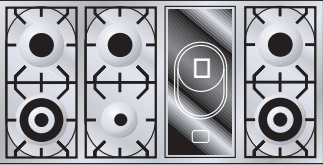
Tipologia piano cottura	Tipologia forno	Codice modello	Prezzo €
7 fuochi 	Multifunzione	PDL-1207-MP	
		PDW-1207-MP	
		PDF-1207-MP	
	A gas ventilato	PDL-1207-VG	
		PDW-1207-VG	
		PDF-1207-VG	
Fry-Top 	Multifunzione	PDL-120F-MP	
		PDW-120F-MP	
		PDF-120F-MP	
	A gas ventilato	PDL-120F-VG	
		PDW-120F-VG	
		PDF-120F-VG	
Coup De Feu 	Multifunzione	PDL-120S-MP	
		PDW-120S-MP	
		PDF-120S-MP	
	A gas ventilato	PDL-120S-VG	
		PDW-120S-VG	
		PDF-120S-VG	
Friggitrice 	Multifunzione	PDL-120FR-MP	
		PDW-120FR-MP	
	A gas ventilato	n.d.	
Barbecue 	Multifunzione	PDL-120B-MP	
		PDW-120B-MP	
		PDF-120B-MP	
	A gas ventilato	PDL-120B-VG	
		PDW-120B-VG	
		PDF-120B-VG	
1 Zona vetroceramica 	Multifunzione	PDL-120V-MP	
		PDW-120V-MP	
		PDF-120V-MP	
	A gas ventilato	PDL-120V-VG	
		PDW-120V-VG	
		PDF-120V-VG	



Optional DUAL 5kW



Sovrapprezzo €

GAMMA COLORI

 Inox	 Grafite-Mat (no PDL-120)
 Bianco (versione PDW-120)	 Nero lucido (versione PDW-120)

PIANO DI LAVORO INOX

Optional DECORI



Sovrapprezzo DEC/PDW120/03/... €

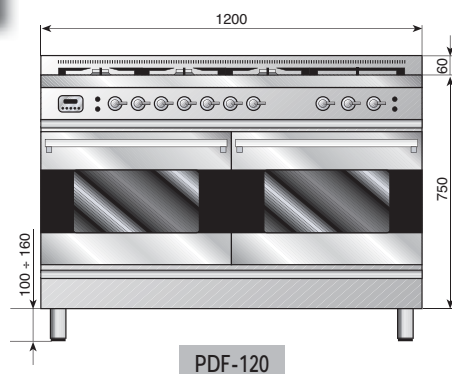
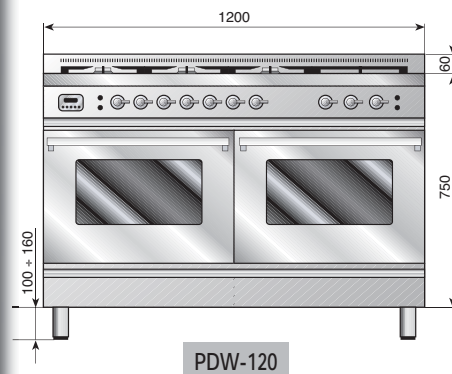
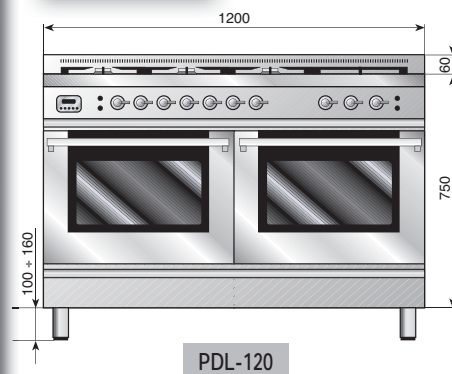

PROFONDITÀ 60



GRUPPO DI COTTURA «PROFESSIONAL PLUS» HI-TECH P-150

CARATTERISTICHE TECNICHE:

Forno di sinistra: maxiforno 90 in versione multifunzione o gas ventilato. Forno di destra: standard 60 multifunzione.





Forno multifunzione 60: • classe energetica **A**; • termostato; • programmatore elettronico; • grill elettrico.

Maxiforno a gas ventilato 90: • termostato con termocoppia; • grill elettrico; • girarrosto.

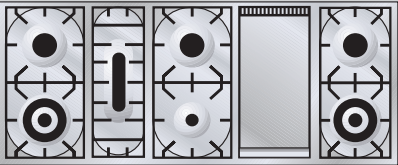
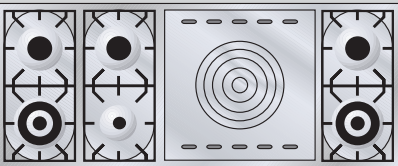
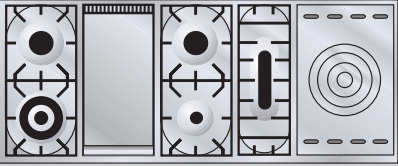
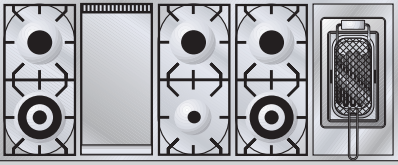
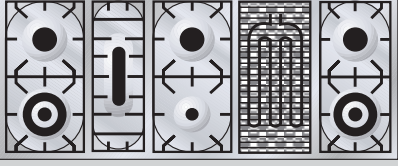
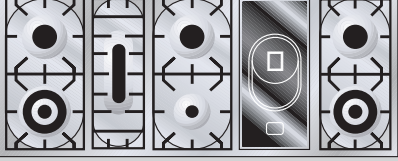
Maxiforno multifunzione 90: • classe energetica **A**; • termostato; • grill elettrico; • girarrosto.

Tutti i modelli sono dotati di porta fredda a triplo vetro.

Tipologia piano cottura	Tipologia forno	Codice modello	Prezzo €
Fry-Top 	Multifunzione	PL-I 50F-MP	
		PW-I 50F-MP	
		PF-I 50F-MP	
	A gas ventilato	PL-I 50F-VG	
		PW-I 50F-VG	
		PF-I 50F-VG	
Coup De Feu 	Multifunzione	PL-I 50S-MP	
		PW-I 50S-MP	
		PF-I 50S-MP	
	A gas ventilato	PL-I 50S-VG	
		PW-I 50S-VG	
		PF-I 50S-VG	
Fry-Top + Coup De Feu 	Multifunzione	PL-I 50FS-MP	
		PW-I 50FS-MP	
		PF-I 50FS-MP	
	A gas ventilato	PL-I 50FS-VG	
		PW-I 50FS-VG	
		PF-I 50FS-VG	
Friggitrice + Fry-Top 	Multifunzione	PL-I 50FR-MP	
		PW-I 50FR-MP	
		PF-I 50FR-MP	
	A gas ventilato	n.d.	
Barbecue 	Multifunzione	PL-I 50B-MP	
		PW-I 50B-MP	
		PF-I 50B-MP	
	A gas ventilato	PL-I 50B-VG	
		PW-I 50B-VG	
		PF-I 50B-VG	
1 Zona vetroceramica 	Multifunzione	PL-I 50V-MP	
		PW-I 50V-MP	
		PF-I 50V-MP	
	A gas ventilato	PL-I 50V-VG	
		PW-I 50V-VG	
		PF-I 50V-VG	

GAMMA COLORI	
	
Inox	Grafite-Mat (no PL-150)
	
Bianco (versione PW-150)	Nero lucido (versione PW-150)
PIANO DI LAVORO INOX	

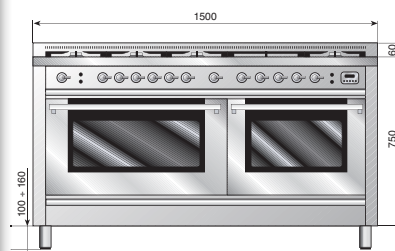
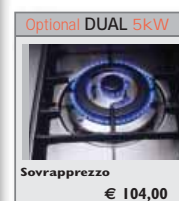

PL-150

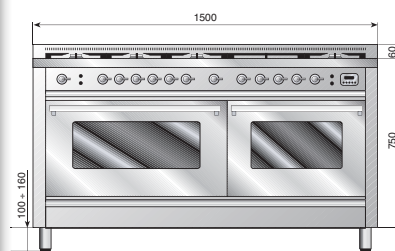

PW-150



Maxiforno 90 cm

Standard 60 cm

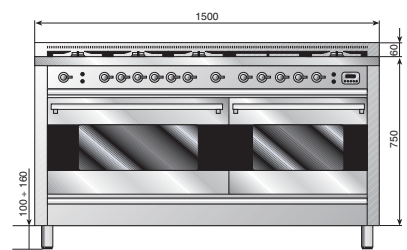

PF-150

PROFONDITÀ 60



CARATTERISTICHE TECNICHE:

Forno multifunzione 60: • classe energetica **A**; • termostato; • programmatore elettronico; • grill elettrico.

Forno a gas ventilato 60: • termostato con termocoppia; • grill elettrico; • programmatore elettronico per funzioni grill e grill ventilato.

Tutti i modelli sono dotati di porta fredda a triplo vetro.

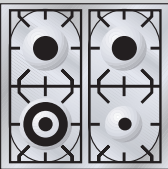
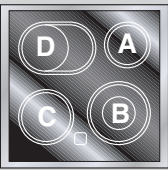
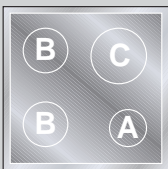
Tipologia piano cottura	Tipologia forno	Codice modello	Fin. Ottone/Cromo €	Fin. Brunite €
4 fuochi 	Multifunzione	PN-60-MP		
	A gas ventilato	PN-60-VG		
Vetroceramica 	Multifunzione	PNE-60MP		
	A - ø 145 mm - 1200W B - ø 210/120 mm - 2200W/750W C - ø 180 mm - 1800W D - ø 265/170 mm - 2400W/1500W			
Induzione 	Multifunzione	PNI-60-MP		
	A - ø 145 mm - 1400W B - ø 180 mm - 1850W C - ø 210 mm - 2300W			

GAMMA COLORI

PIANO DI LAVORO INOX

FINITURE

OTTONE (di serie)

CROMO (a richiesta senza sovrapprezzo)

BRUNITE (a richiesta con sovrapprezzo)

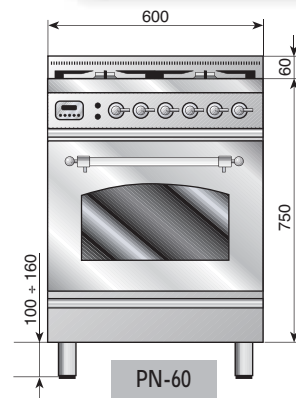



CARATTERISTICHE TECNICHE:

Forno multifunzione 60: • classe energetica **A** • termostato; • programmatore elettronico; • grill elettrico

Forno a gas ventilato 60: • termostato con termocoppia; • grill elettrico; • programmatore elettronico per funzioni grill e grill ventilato.

Tutti i modelli sono dotati di porta fredda a triplo vetro.

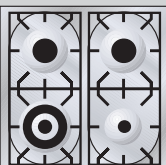
Tipologia piano cottura	Tipologia forno	Codice modello	Fin. Ottone/Cromo €	Fin. Brunite €
4 fuochi 	Multifunzione	PN-70-MP		
	A gas ventilato	PN-70-VG		

GAMMA COLORI		
		
Inox	Grafite-Mat	Bianco Antico
		
Rosso borgogna	Blu	Verde smeraldo
		
Bianco	Nero lucido	

PIANO DI LAVORO INOX

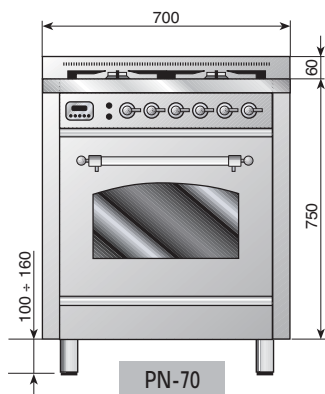

FINITURE	
	
OTTONE (di serie)	
	
CROMO (a richiesta senza sovrapprezzo)	
	
BRUNITE (a richiesta con sovrapprezzo)	



PROFONDITÀ 60



CARATTERISTICHE TECNICHE:

Maxiforno multifunzione 90: • classe energetica **A**; • termostato; • programmatore elettronico; • girarrosto; • grill elettrico.

Maxiforno a gas ventilato 90: • termostato con termocoppia; • grill elettrico; • programmatore elettronico per funzioni grill e grill ventilato.

Tutti i modelli sono dotati di porta fredda a triplo vetro.

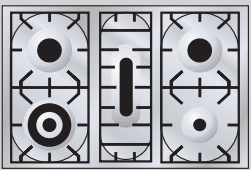
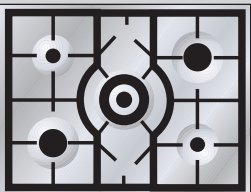
Tipologia piano cottura	Tipologia forno	Codice modello	Fin. Ottone/Cromo €	Fin. Brunite €
Pesciera 	Multifunzione	PN-80-MP		
	A gas ventilato	PN-80-VG		
5 fuochi 	Multifunzione	PN-80C-MP		
	A gas ventilato	PN-80C-VG		

GAMMA COLORI

		
Inox	Grafite-Mat	Bianco Antico
		
Rosso bor-gogna	Blu	Verde smeraldo
		
Bianco	Nero lucido	

PIANO DI LAVORO INOX

FINITURE

	
OTTONE (di serie)	
	
CROMO (a richiesta senza sovrapprezzo)	
	
BRUNITE (a richiesta con sovrapprezzo)	



Optional **DUAL 5kW**



Sovrapprezzo €

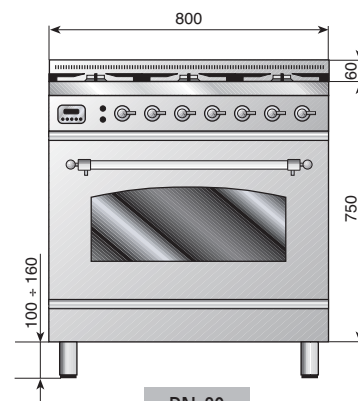

PN-80

PROFONDITÀ 60







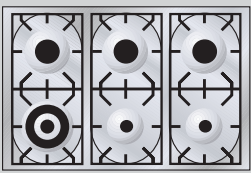
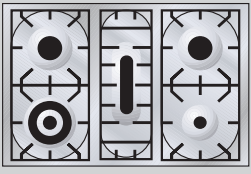
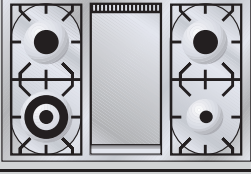
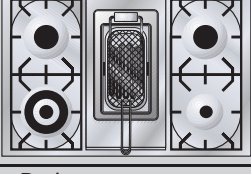
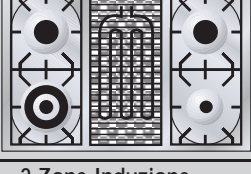

CARATTERISTICHE TECNICHE:

Maxiforno multifunzione 90: • classe energetica **A**; • termostato; • programmatore elettronico; • girarrosto; • grill elettrico.

Maxiforno a gas ventilato 90: • termostato con termocoppia; • grill elettrico; • programmatore elettronico per funzioni grill e grill ventilato.

Tutti i modelli sono dotati di porta fredda a triplo vetro.

Tipologia piano cottura	Tipologia forno	Codice modello	Fin. Ott./Cromo €	Fin. Brunite €
6 fuochi 	Multifunzione	PN-906-MP		
	A gas ventilato	PN-906-VG		
Pesciera 	Multifunzione	PN-90-MP		
	A gas ventilato	PN-90-VG		
Fry-Top 	Multifunzione	PN-90F-MP		
	A gas ventilato	PN-90F-VG		
Friggitrice 	Multifunzione	PN-90R-MP		
	A gas ventilato	n.d.		
Barbecue 	Multifunzione	PN-90B-MP		
	A gas ventilato	PN-90B-VG		
2 Zone Induzione 	Multifunzione	PN-90 I-MP		
	Optional Fry TopG/419/08 2 x 1850 W 			
Vetroceramica 	Multifunzione	PNE-90-MP		
	A - ø 145 mm - 1200W B - ø 210/120 mm - 2200W/750W C - ø 180 mm - 1800W D - ø 265/170 mm - 2400W/1500W			
Induzione 	Multifunzione	PNI-90-MP		
	A - ø 145 mm - 1400W B - ø 180 mm - 1850W C - ø 210 mm - 2300W D - ø 260 mm - 2400W 			

GAMMA COLORI



PIANO DI LAVORO INOX

FINITURE



DUAL

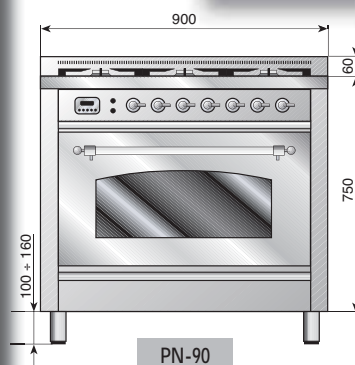

PROFONDITÀ 60



PN-906-MP/BX



GRUPPO DI COTTURA «PROFESSIONAL PLUS» *Nostalgie* PDN-90

CARATTERISTICHE TECNICHE:





Forno di sinistra: standard 60 in versione multifunzione o gas ventilato. Forno di destra: mini 30 elettrico statico.

Forno multifunzione 60: • classe energetica **A**; • termostato; • programmatore elettronico; • grill elettrico.

Mini forno elettrico 30: • classe energetica **A**; • grill elettrico; • girarrosto.

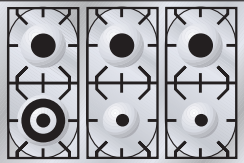
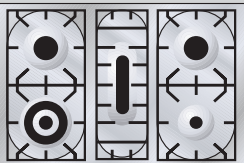
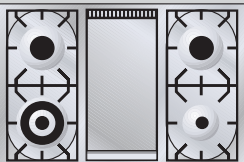
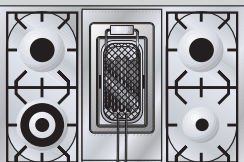
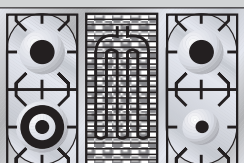
Forno a gas ventilato 60: • termostato con termocoppia; • grill elettrico; • programmatore elettronico.

Tutti i modelli sono dotati di porta fredda a triplo vetro.

Tipologia piano cottura	Tipologia forno	Codice modello	Fin. Ott./Cromo €	Fin. Brunite €
6 fuochi 	Multifunzione	PDN-906-MP		
	A gas ventilato	PDN-906-VG		
Pesciera 	Multifunzione	PDN-90-MP		
	A gas ventilato	PDN-90-VG		
Fry-Top 	Multifunzione	PDN-90F-MP		
	A gas ventilato	PDN-90F-VG		
Friggitrice 	Multifunzione	PDN-90R-MP		
	A gas ventilato	n.d.		
Barbecue 	Multifunzione	PDN-90B-MP		
	A gas ventilato	PDN-90B-VG		
1 Zona vetroceramica 	Multifunzione	PDN-90V-MP		
	A gas ventilato	PDN-90V-VG		
Vetroceramica 	Multifunzione	PDNE-90-MP		
	A - ø 145 mm - 1200W B - ø 210/120 mm - 2200W/750W C - ø 180 mm - 1800W D - ø 265/170 mm - 2400W/1500W			
Induzione 	Multifunzione	PDNI-90-MP		
	A - ø 145 mm - 1400W B - ø 180 mm - 1850W C - ø 210 mm - 2300W D - ø 260 mm - 2400W			



GAMMA COLORI

PIANO DI LAVORO INOX

FINITURE

 
OTTONE (di serie)

 
CROMO
 (a richiesta senza sovrapprezzo)

 
BRUNITE
 (a richiesta con sovrapprezzo)

Optional **DUAL 5kW**



Sovrapprezzo
€

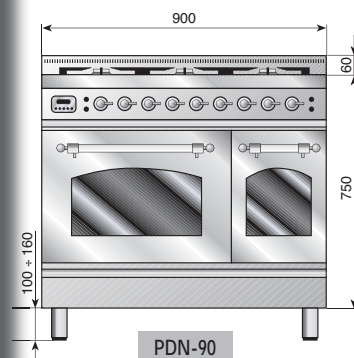

PROFONDITÀ 60



GRUPPO DI COTTURA «PROFESSIONAL PLUS» *Nostalgie* PDN-100



*Microonde su forno Midi 40

CARATTERISTICHE TECNICHE:

Forno di sinistra: standard 60 in versione multifunzione o gas ventilato. Forno di destra: midi 40 elettrico statico.

Forno multifunzione 60: • classe energetica **A**; • termostato; • programmatore elettronico; • grill elettrico.

Midi forno elettrico 40: • classe energetica **A**; • grill elettrico; • girarrosto.

Forno a gas ventilato 60: • termostato con termocoppia; • grill elettrico; • programmatore elettronico.

Tutti i modelli sono dotati di porta fredda a triplo vetro.

6 fuochi *	Multifunzione	A gas ventilato	Multifunzione 60 - Microonde 40 (con controllo E3 300°C)															
	PDN-1006-MP Finiture ott/cromo € Finiture brunite €	PDN-1006-VG Finiture ott/cromo € Finiture brunite €	PDN-1006-MW Finiture ott/cromo € Finiture brunite €															
Fry-Top * 	PDN-100F-MP Finiture ott/cromo € Finiture brunite €	PDN-100F-VG Finiture ott/cromo € Finiture brunite €	PDN-100F-MW Finiture ott/cromo € Finiture brunite €															
Coup De Feu 	PDN-100S-MP Finiture ott/cromo € Finiture brunite €	PDN-100S-VG Finiture ott/cromo € Finiture brunite €																
Friggitrice 	PDN-100R-MP Finiture ott/cromo € Finiture brunite €																	
Barbecue 	PDN-100B-MP Finiture ott/cromo € Finiture brunite €	PDN-100B-VG Finiture ott/cromo € Finiture brunite €																
1 Zona vetroceramica 	PDN-100V-MP Finiture ott/cromo € Finiture brunite €	PDN-100V-VG Finiture ott/cromo € Finiture brunite €																
Vetroceramica 	PDNE-100-MP Finiture ott/cromo € Finiture brunite €	<table border="1"> <thead> <tr> <th></th> <th>ø mm</th> <th>W</th> </tr> </thead> <tbody> <tr> <td>A</td> <td>145</td> <td>1200</td> </tr> <tr> <td>B</td> <td>210/120</td> <td>2200/750</td> </tr> <tr> <td>C</td> <td>180</td> <td>1800</td> </tr> <tr> <td>D</td> <td>265/170</td> <td>2400/1500</td> </tr> </tbody> </table>		ø mm	W	A	145	1200	B	210/120	2200/750	C	180	1800	D	265/170	2400/1500	PDNE-100-MW Finiture ott/cromo € Finiture brunite €
	ø mm	W																
A	145	1200																
B	210/120	2200/750																
C	180	1800																
D	265/170	2400/1500																
Induzione 	PDNI-100-MP Finiture ott/cromo € Finiture brunite €	<table border="1"> <thead> <tr> <th></th> <th>ø mm</th> <th>W</th> </tr> </thead> <tbody> <tr> <td>A</td> <td>145</td> <td>1400</td> </tr> <tr> <td>B</td> <td>180</td> <td>1850</td> </tr> <tr> <td>C</td> <td>210</td> <td>2300</td> </tr> </tbody> </table>		ø mm	W	A	145	1400	B	180	1850	C	210	2300	PDNI-100-MW Finiture ott/cromo € Finiture brunite €			
	ø mm	W																
A	145	1400																
B	180	1850																
C	210	2300																

GAMMA COLORI

Inox	Grafite-Mat	Bianco Antico
Rosso bor-gogna	Blu	Verde smeraldo
Bianco	Nero lucido	

PIANO DI LAVORO INOX

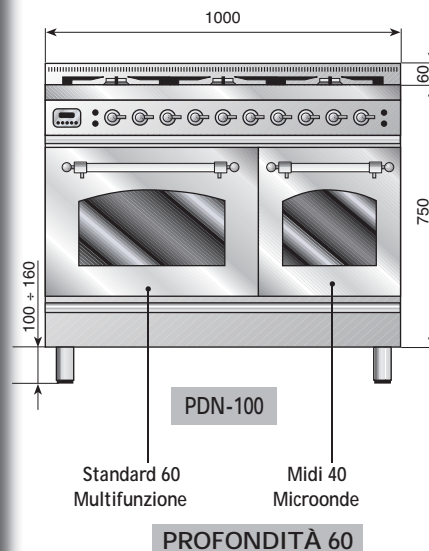
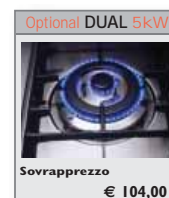





GRUPPO DI COTTURA «PROFESSIONAL PLUS» *Nostalgie* PTN-100

CARATTERISTICHE TECNICHE:

Forni lato sinistro - Superiore: • grill elettrico. Inferiore: multifunzione 60: • classe energetica **A**; • termostato; • programmatore elettronico; • grill elettrico.

Forno lato destro - Superiore: midi 40 elettrico: • classe energetica **A**; • grill elettrico; • girarrosto. Cassetto portaoggetti.

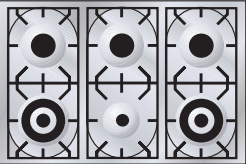
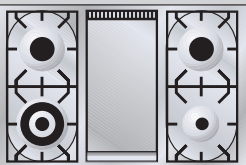
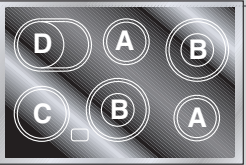
Tutti i modelli sono dotati di porta fredda a triplo vetro.

Tipologia piano cottura	Tipologia forno	Codice modello	Fin. Ott./Cromo €	Fin. Brunite €
6 fuochi 	Multifunzione	PTN-1006-MP		
Fry-Top 	Multifunzione	PTN-100F-MP		
Vetroceramica 	Multifunzione	PTNE-100-MP		
A - ø 145 mm - 1200W B - ø 210/120 mm - 2200W/750W C - ø 180 mm - 1800W D - ø 265/170 mm - 2400W/1500W				
Induzione 	Multifunzione	PTNI-100-MP		
A - ø 145 mm - 1400W B - ø 180 mm - 1850W C - ø 210 mm - 2300W				

GAMMA COLORI



PIANO DI LAVORO INOX

FINITURE



Optional DUAL 5kW

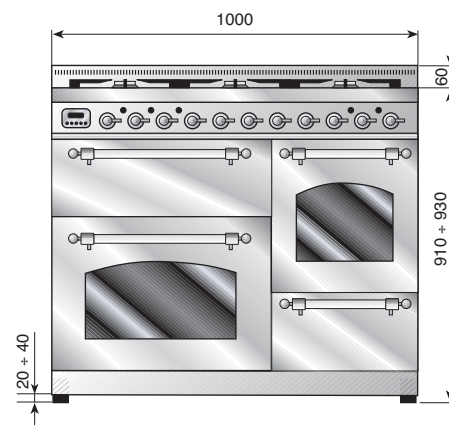

PTN-100

PROFONDITÀ 60



GRUPPO DI COTTURA «PROFESSIONAL PLUS» *Nostalgie* PN-120

CARATTERISTICHE TECNICHE:



Forno di sinistra: maxiforno 90 in versione multifunzione o gas ventilato. Forno di destra: mini 30 elettrico statico.

Maxiforno multifunzione 90: • classe energetica **A**; • termostato; • programmatore elettronico; • girarrosto; • grill elettrico.

MiniForno elettrico 30: • classe energetica **A**; • grill elettrico; • girarrosto.

Maxiforno a gas ventilato 90: • termostato con termocoppia; • grill elettrico; • girarrosto; • programmatore elettronico.

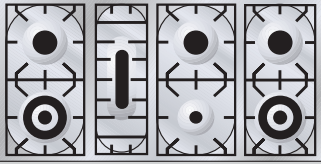
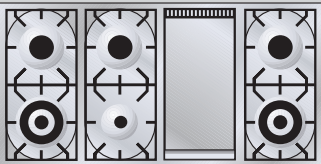
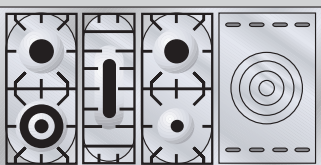
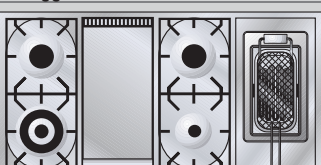
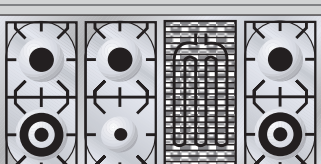
Tutti i modelli sono dotati di porta fredda a triplo vetro.

Tipologia piano cottura	Tipologia forno	Codice modello	Fin. Ott./Cromo €	Fin. Brunite €
7 fuochi 	Multifunzione	PN-1207-MP		
	A gas ventilato	PN-1207-VG		
Fry-Top 	Multifunzione	PN-120F-MP		
	A gas ventilato	PN-120F-VG		
Coup De Feu 	Multifunzione	PN-120S-MP		
	A gas ventilato	PN-120S-VG		
Friggitrice 	Multifunzione	PN-120FR-MP		
	A gas ventilato	n.d.		
Barbecue 	Multifunzione	PN-120B-MP		
	A gas ventilato	PN-120B-VG		
1 Zona vetroceramica 	Multifunzione	PN-120V-MP		
	A gas ventilato	PN-120V-VG		

GAMMA COLORI



PIANO DI LAVORO INOX

FINITURE



OTTONE (di serie)



CROMO
(a richiesta senza sovrapprezzo)



BRUNITE
(a richiesta con sovrapprezzo)

Optional DUAL 5KW



Sovrapprezzo

€



Maxiforno 90 cm

Mini 30 cm

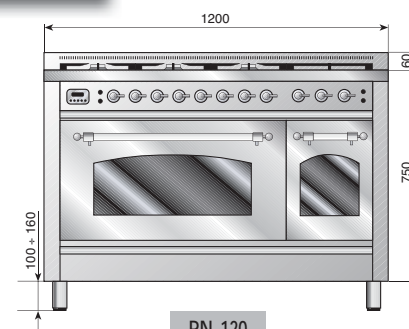

PN-120

PROFONDITÀ 60



GRUPPO DI COTTURA «PROFESSIONAL PLUS» *Nostalgie* PSN-120

CARATTERISTICHE TECNICHE:

Forno di sinistra: maxiforno 70 in versione multifunzione o gas ventilato. Forno di destra: midi 40 elettrico statico.

Maxiforno multifunzione 70: • classe energetica **A**; • termostato; • programmatore elettronico; • girarrosto; • grill elettrico.

Maxiforno a gas ventilato 70: • termostato con termocoppia; • grill elettrico; • programmatore elettronico.

MidiForno elettrico 40: • classe energetica **A**; • grill elettrico; • girarrosto.

Tutti i modelli sono dotati di porta fredda a triplo vetro.

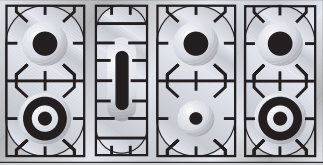
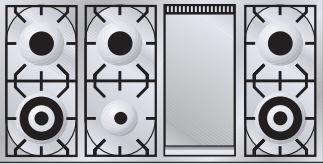
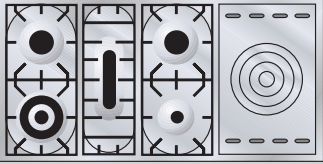
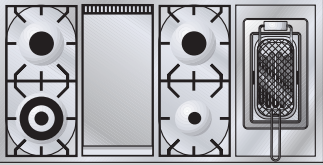
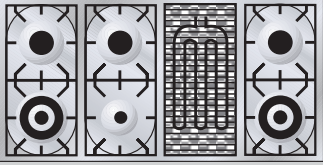
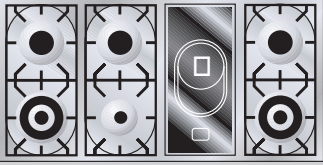
Tipologia piano cottura	Tipologia forno	Codice modello	Fin. Ott./Cromo €	Fin. Brunate €
7 fuochi 	Multifunzione	PSN-1207-MP		
	A gas ventilato	PSN-1207-VG		
Fry-Top 	Multifunzione	PSN-120F-MP		
	A gas ventilato	PSN-120F-VG		
Coup De Feu 	Multifunzione	PSN-120S-MP		
	A gas ventilato	PSN-120S-VG		
Friggitrice 	Multifunzione	PSN-120FR-MP		
	A gas ventilato	n.d.		
Barbecue 	Multifunzione	PSN-120B-MP		
	A gas ventilato	PSN-120B-VG		
1 Zona vetroceramica 	Multifunzione	PSN-120V-MP		
	A gas ventilato	PSN-120V-VG		

GAMMA COLORI

Inox	Grafite-Mat	Bianco Antico
Rosso borgogna	Blu	Verde smeraldo
Bianco	Nero lucido	

PIANO DI LAVORO INOX

FINITURE

 
OTTONE (di serie)

 
CROMO (a richiesta senza sovrapprezzo)

 
BRUNITE (a richiesta con sovrapprezzo)

Optional **DUAL 5kW**



Sovrapprezzo €



Forno 70 cm

Midi 40 cm

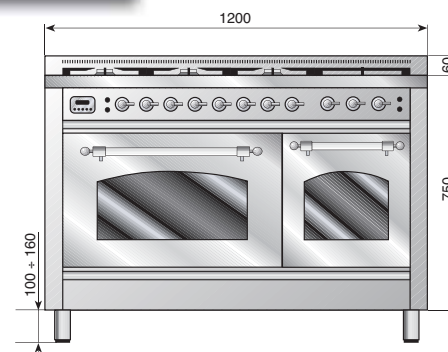

PSN-120

PROFONDITÀ 60



GRUPPO DI COTTURA «PROFESSIONAL PLUS» *Nostalgie* PDN-120





CARATTERISTICHE TECNICHE:

Forno di sinistra: standard 60 in versione multifunzione o gas ventilato. Forno di destra: standard 60 multifunzione.

Forno multifunzione 60: • classe energetica **A**; • termostato; • programmatore elettronico; • grill elettrico.

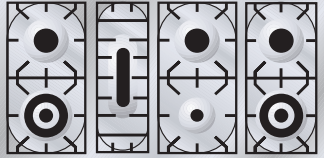
Forno a gas ventilato 60: • termostato con termocoppia; • grill elettrico; • programmatore elettronico.

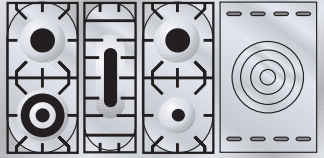
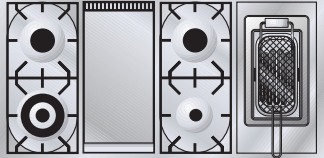
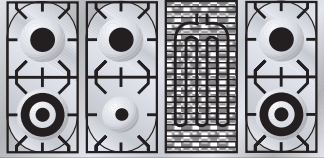
Tutti i modelli sono dotati di porta fredda a triplo vetro.

Tipologia piano cottura	Tipologia forno	Codice modello	Finiture Ott./Cromo €	Finiture Brunite €
7 fuochi 	Multifunzione	PDN-1207-MP		
	A gas ventilato	PDN-1207-VG		
Fry-Top 	Multifunzione	PDN-120F-MP		
	A gas ventilato	PDN-120F-VG		
Coup De Feu 	Multifunzione	PDN-120S-MP		
	A gas ventilato	PDN-120S-VG		
Friggitrice 	Multifunzione	PDN-120FR-MP		
	A gas ventilato	n.d.		
Barbecue 	Multifunzione	PDN-120B-MP		
	A gas ventilato	PDN-120B-VG		
1 Zona vetroceramica 	Multifunzione	PDN-120V-MP		
	A gas ventilato	PDN-120V-VG		

GAMMA COLORI

Inox	Grafite-Mat	Bianco Antico
Rosso borgogna	Blu	Verde smeraldo
Bianco	Nero lucido	

PIANO DI LAVORO INOX

FINITURE

OTTONE (di serie)	
CROMO (a richiesta senza sovrapprezzo)	
BRUNITE (a richiesta con sovrapprezzo)	

Optional DUAL 5kW



Sovrapprezzo
€

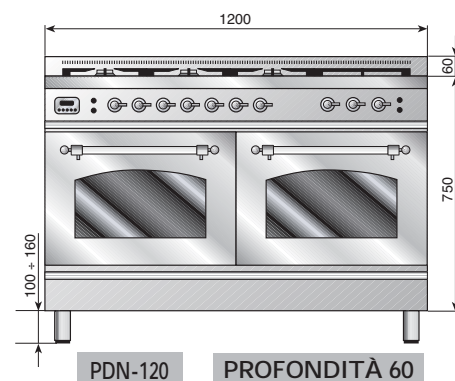



GRUPPO DI COTTURA «PROFESSIONAL PLUS» *Nostalgie* PN-I 50

CARATTERISTICHE TECNICHE:

Forno di sinistra: maxiforno 90 in versione multifunzione o gas ventilato. Forno di destra: standard 60 multifunzione.

Forno multifunzione 60: • classe energetica **A**; • termostato; • programmatore elettronico; • grill elettrico.

Maxiforno a gas ventilato 90: • termostato con termocoppia; • grill elettrico; • girarrosto.

Maxiforno multifunzione 90: • classe energetica **A**; • termostato; • grill elettrico; • girarrosto.

Tutti i modelli sono dotati di porta fredda a triplo vetro.

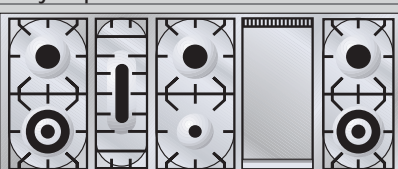
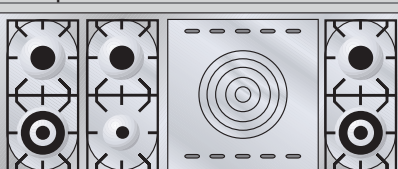
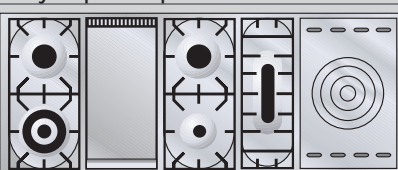
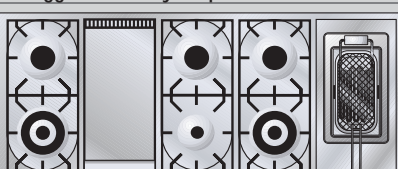
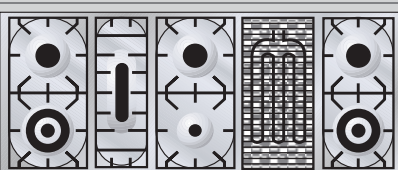
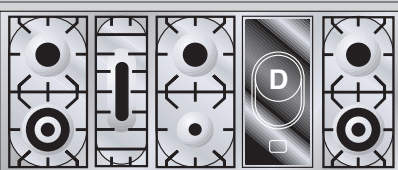
Tipologia piano cottura	Tipologia forno	Codice modello	Finiture Ott./Cromo €	Finiture Brunate €
Fry-Top 	Multifunzione	PN-I 50F-MP		
	A gas ventilato	PN-I 50F-VG		
Coup De Feu 	Multifunzione	PN-I 50S-MP		
	A gas ventilato	PN-I 50S-VG		
Fry-Top + Coup De Feu 	Multifunzione	PN-I 50FS-MP		
	A gas ventilato	PN-I 50FS-VG		
Friggitrice + Fry-Top 	Multifunzione	PN-I 50FR-MP		
	A gas ventilato	n.d.		
Barbecue 	Multifunzione	PN-I 50B-MP		
	A gas ventilato	PN-I 50B-VG		
1 Zona vetroceramica 	Multifunzione	PN-I 50V-MP		
	A gas ventilato	PN-I 50V-VG		

GAMMA COLORI		
		
Inox	Grafite-Mat	Bianco Antico
		
Rosso bor-gogna	Blu	Verde smeraldo
		
Bianco	Nero lucido	

PIANO DI LAVORO INOX

FINITURE	
	
OTTONE (di serie)	
	
CROMO (a richiesta senza sovrapprezzo)	
	
BRUNITE (a richiesta con sovrapprezzo)	

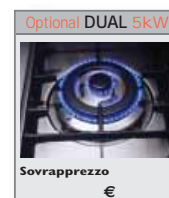

Maxiforno 90 cm

Standard 60 cm

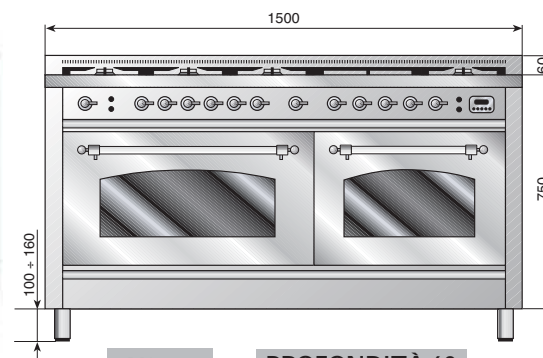

PN-150

PROFONDITÀ 60

